



# TAYLOR 40"

Category: Bathroom Vanity

Material: Wood

Dimensions:

39.4" (L) x 19.8" (W) x 17.8" (H)

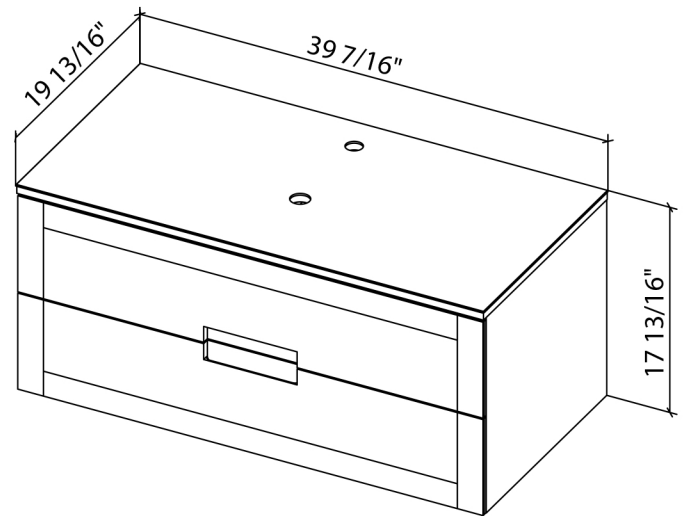

## Technical Data

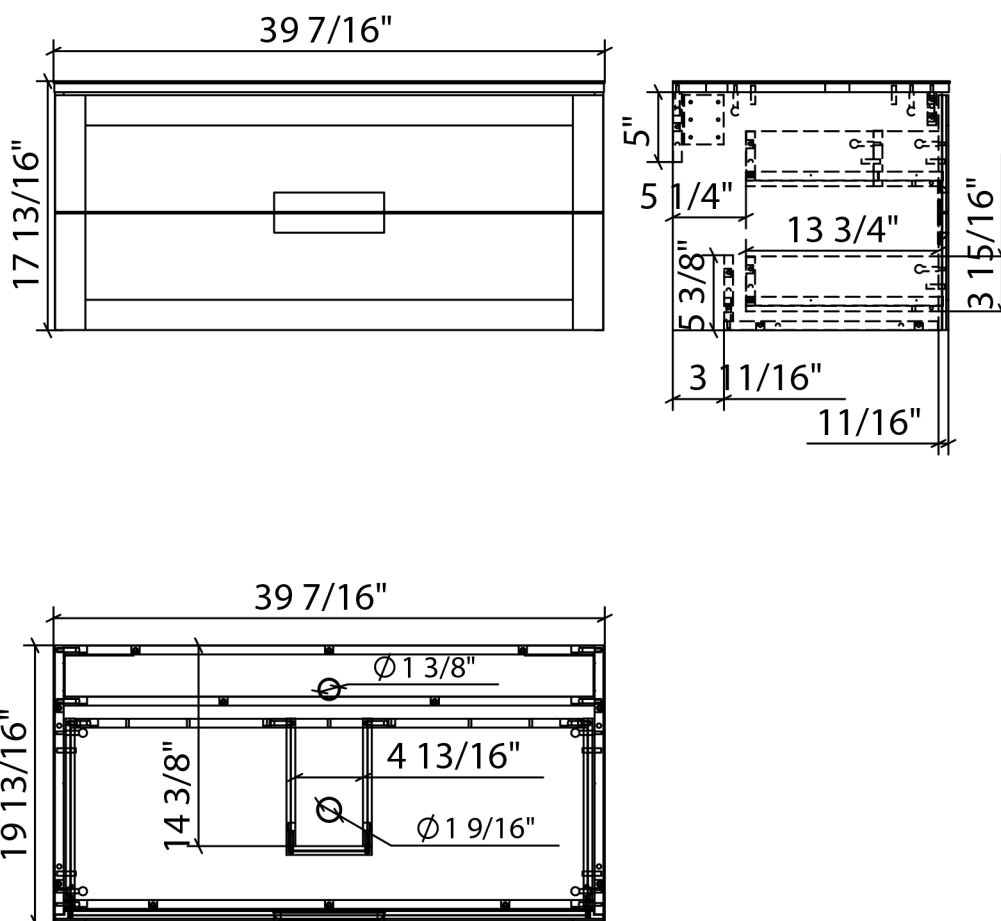

\*Numbers are in inches

### TOOLS REQUIRED FOR ASSEMBLY

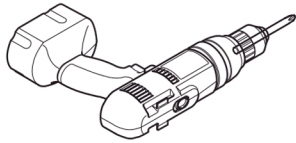

Electrical Drill

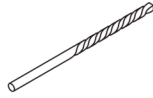

Drill Bit

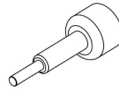

Bolt Bit

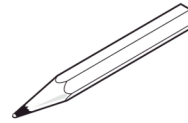

Pencil

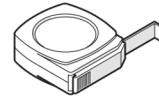

Tape Measure



Phillips  
Screwdriver

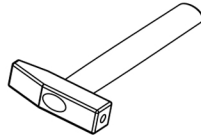

Hammer

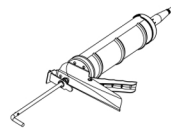

Silicone

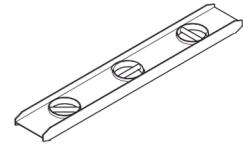

Level

### FURNITURE

**A**

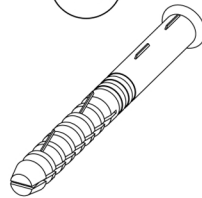

4 PCS

**B**

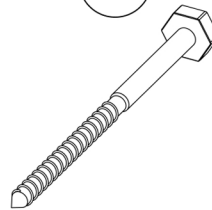

4 PCS

### Wall Preparation

The recommended height for a console cabinet with sink is 33-1/2". This requires installing a 14" wide wood panel to a height of 34-1/4". If an alternate height desired, adjust the rough-in and backing material heights using the dimensions provided.

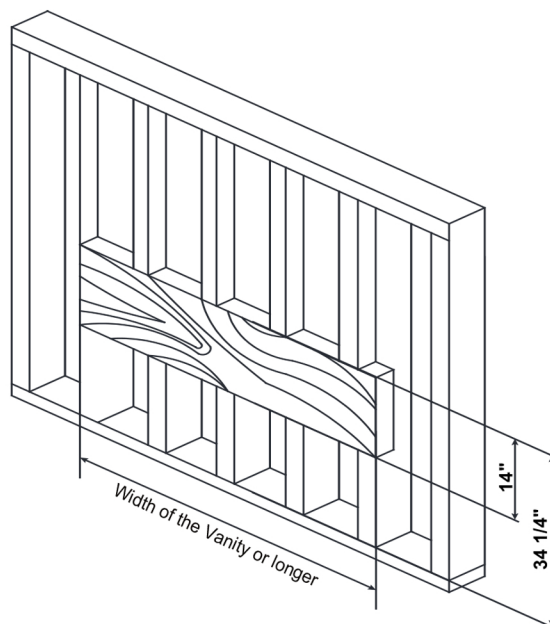

**STEP 1.**

**Marking for the cabinet**  
Having decided on the location of the cabinet, we mark and drill holes in the wall measuring the distance A, B, C

**WARNING:**  
Before installing the cabinet must be removed drawers.

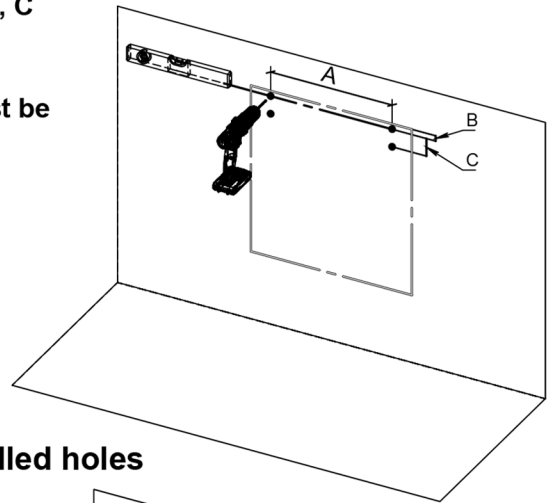

**STEP 2.**

**Install the cabinet on the drilled holes**

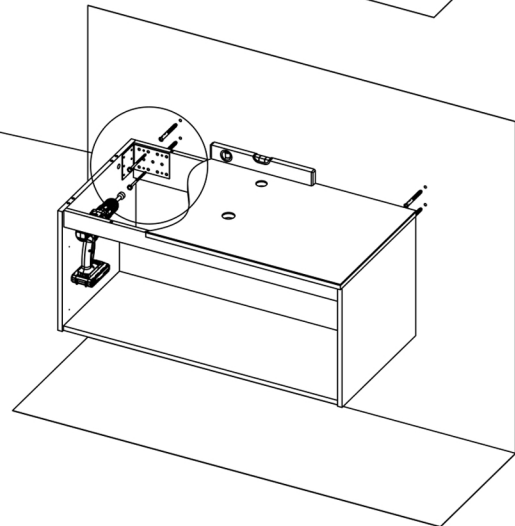
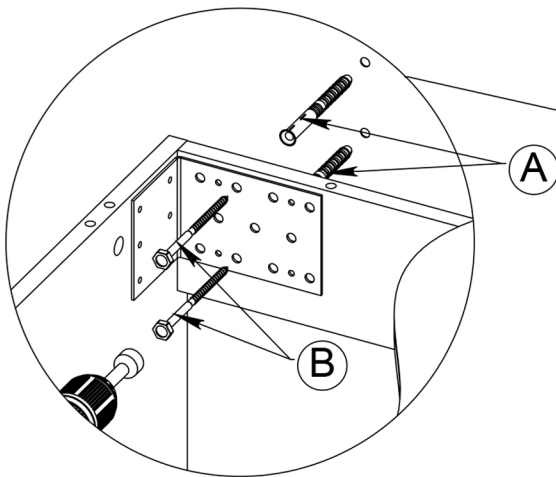

**STEP 3.**

**Fill the side against the wall with Silicone and finish**

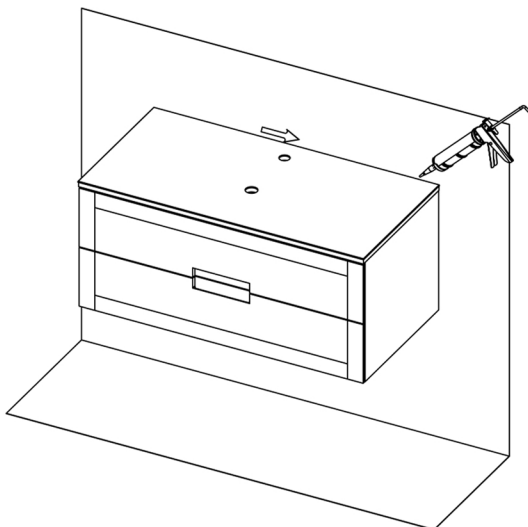

**STEP 4.**

**Install sink top with Silicone**

